

D05 Cover Plate

SOURCE SELLS SOLUTIONS.

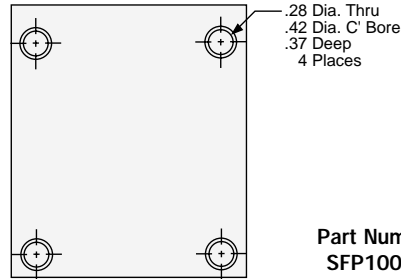
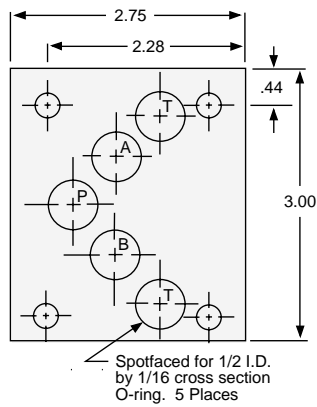

Pressure Rating: 3000 psi

Material: 6061-T6 Aluminum

Items Furnished with Cover Plate:

- Four (4) 1/4-20 X 3/4 long socket head cap screws (90009)
- Five (5) Viton O-rings (90003) AS 568A-014

Part Number
SFP10080
without gauge port



Part Number
SFP10130
with gauge port

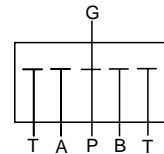

Part Number
SFP10131

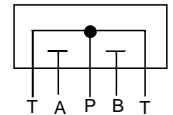

D05 Tapping Plate

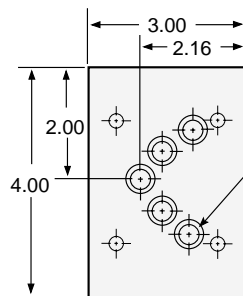
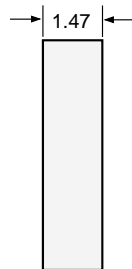
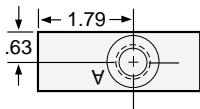

.28 Dia. Thru (4)

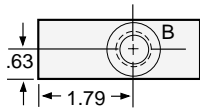

Port Size: 3/4-16 O-ring ports (2) (SAE -8)

Pressure Rating: 3000 psi

Material: 6061-T6 Aluminum

Five (5) Viton O-rings (90003) are furnished with each tapping plate - AS 568A-014

A & B Ports
Part No. SFP10136

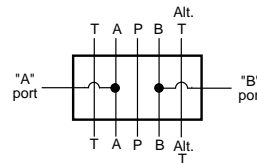

P & T Ports
Part No. SFP10137

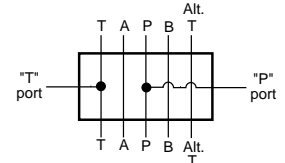

D03 Valve Adaptor

D05 Manifold

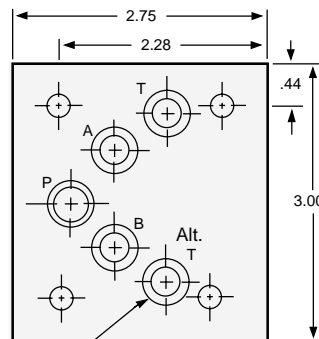
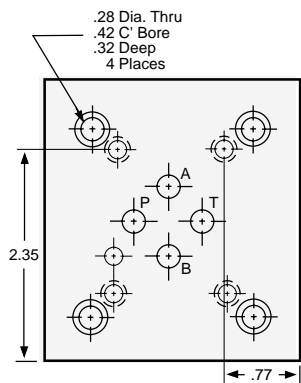

Pressure Rating: 3000 psi

Material: 6061-T6 Aluminum

Items Furnished with Adaptor:

- Four (4) 1/4-20 X 1-1/2 inch long socket head cap screws (90022)
- Five (5) Viton O-rings for the manifold surface (90003) AS 568A-014

Part No. SFP10140
"A" = 0.98"

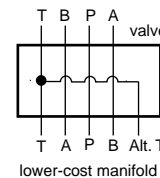

Part No. SFP10141
"A" = 1.45"

